

# X-LITE™

## DIRECT

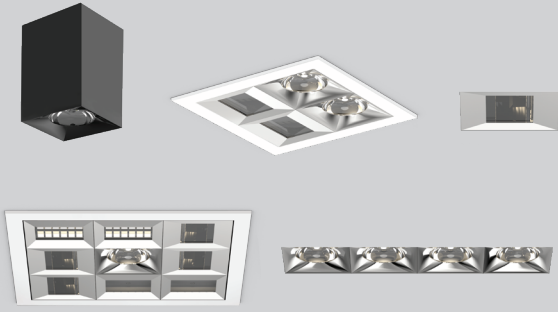

### CERTIFICATIONS & COMPLIANCE



### FEATURES



### PERFORMANCE

- Up to 70 lm/W
- Multipurpose lighting system
- Multiple lens and housing options
- Recessed, surface, suspended

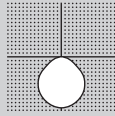

### HOUSING OPTIONS

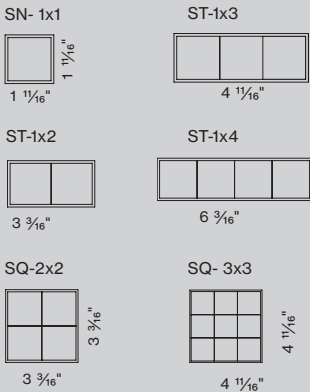

SIDE VIEW

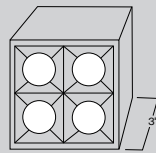

\*HEIGHT IS 3" FOR ALL MOUNTING TYPES

### DIMENSIONS

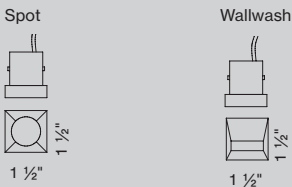

### Specification/Instructions

Use the drop downs to select each cells attribute.

1. Select mounting type, housing color, color temperature, and cell color
2. Select Dim Config for cell formation
3. Cell attribute will auto fill depending on selection made for each cell.

#### Mounting

#### Housing Color

#### Color temp

#### Cell Color

#### Dim Config.

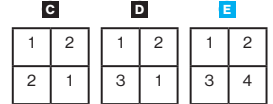
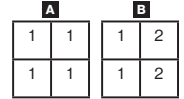

Cell 1	Cell 2
Lens: <input type="text"/>	Lens: <input type="text"/>
DIM Config: <input type="text"/>	DIM Config: <input type="text"/>
NOTES: <input type="text"/>	NOTES: <input type="text"/>
Cell 3	Cell 4
Lens: <input type="text"/>	Lens: <input type="text"/>
DIM Config: <input type="text"/>	DIM Config: <input type="text"/>
NOTES: <input type="text"/>	NOTES: <input type="text"/>

### Attributes Key

Use the housing and cell attributes key.

#### Dim Config.



Housing Attributes Key		Cell Attributes Key	
<b>A RANGE</b>	XLITE XLITE	<b>A CELL TRIM COLOR</b>	B G Black Gloss B M Black Matte C H Chrome W G White Gloss W M White Matte
<b>B PATTERN</b>	Single 1x1 SN 1 x 1 Straight 1x2 ST 1 x 2 Straight 1x3 ST 1 x 3 Straight 1x4 ST 1 x 4 Square 2x2 SQ 2 x 2 Square 3x3 SQ 3 x 3	<b>C CELL COLOR TEMPERATURE</b>	2700K CRI90 2 7 3000K CRI 90 3 0 3500K CRI 90 3 5 4000K CRI 90 4 0
<b>C MOUNTING</b>	Recessed Trimless R T L Recessed Trim R T R Surface Mounted S U R Pendant P D T	<b>D CELL DIMMING CHANNEL</b>	Channel 1 C 1 Channel 2 C 2 Channel 3 C 3 Channel 4 C 4
<b>D HOUSING COLOR</b>	White W H Black B L Gray G R	*RTL in white only	
<b>E DIMMING CHANNEL</b>	single channel C 1 dual channel C 2 three channel C 3 four channel C 4		

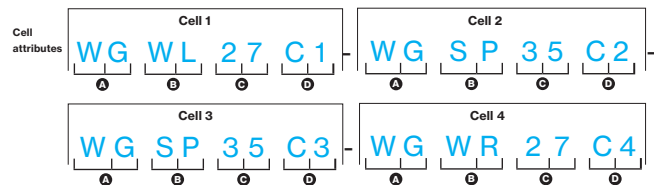
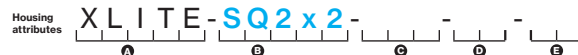

### Diagram Example

**TOP ROW:** Cells 1-2  
**Cell 1:** White Gloss cell color, Wall Wash, light shinning left, and 2700K CRI90 temp.  
**Cell 2:** White Gloss, Spotlight, 3500K CRI90 temp.

**SECOND ROW:** Cells 3-4  
**Cell 3:** White Gloss, Spotlight, 3500K CRI90 temp.  
**Cell 4:** White Gloss cell color, Wall Wash, light shinning right, and 2700K CRI90 temp.

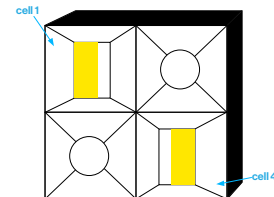

**BASO**  
basolighting.com

# X-LITE™

## SN1X1

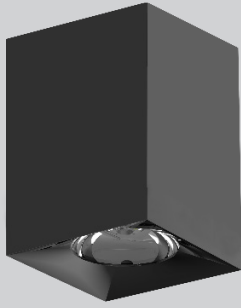

### MOUNTING

### HOUSING COLOR

\*RTL in white only

### COLOR TEMP

### CELL COLOR

### DIM CONFIG.



### CERTIFICATIONS & COMPLIANCE



### FEATURES

**5 YEAR**  
limited  
led warranty



### PERFORMANCE

- Up to 70lm/W efficiency
- Multiple lens options
- Recessed, surface & pendant
- CRI > 90

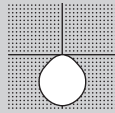

### DIAGRAM

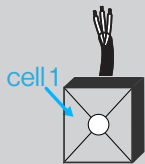

### SINGLE CELL LIGHT DISTRIBUTIONS

#### SPOT LENS 14°

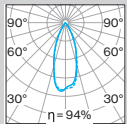

C0 C180  
C90 C270  
LED array 2.3W / 245lm  
106 lm/W

#### MEDIUM LENS 30°

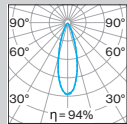

C0 C180  
C90 C270  
LED array 2.3W / 225lm  
98 lm/W

#### FLOOD LENS 36°

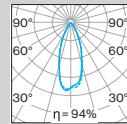

C0 C180  
C90 C270  
LED array 2.3W / 235lm  
101 lm/W

#### WIDE LENS 57°

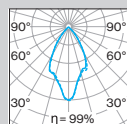

C0 C180  
C90 C270  
LED array 2.3W / 215lm  
93 lm/W

#### WALL WASH

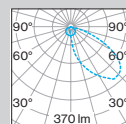

C0 C180  
C90 C270  
LED array 4.9 W / 365lm  
75 lm/W

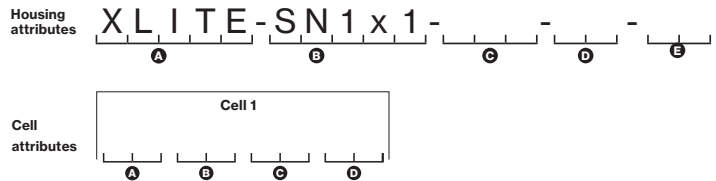
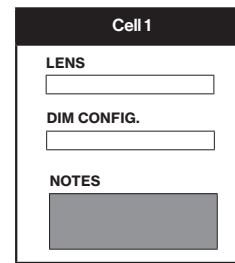

Housing Configuration Code  
**XLITES10 00**

Cell Configuration Code  
**XCS1 00 0**

**BASO**  
basolighting.com

## Power supply

### 1. LINE CONTROL

#### X-LITE 0-10V POWER SUPPLIES

	<b>SPOT CELLS</b>	<b>WALLWASH CELLS</b>
1 cell	XLPS - 12 - SP - 001	XLPS - 12 - WW - 001
2 cell	XLPS - 12 - SP - 002	XLPS - 12 - WW - 002
3 cell	XLPS - 12 - SP - 003	XLPS - 12 - WW - 003
4 cell	XLPS - 12 - SP - 004	XLPS - 12 - WW - 004
5 cell	XLPS - 12 - SP - 005	XLPS - 12 - WW - 005
6 cell	XLPS - 12 - SP - 006	XLPS - 12 - WW - 006
7 cell	XLPS - 12 - SP - 007	XLPS - 12 - WW - 007
8 cell	XLPS - 12 - SP - 008	XLPS - 12 - WW - 008
9 cell	XLPS - 12 - SP - 009	XLPS - 12 - WW - 009

\*X-Lite configurations with both Spot and Wallwash cells will need two separate remote drivers

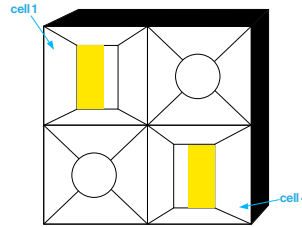

## Wiring diagrams

### 1. LINE CONTROL

#### 0-10V DIM Single Circuit

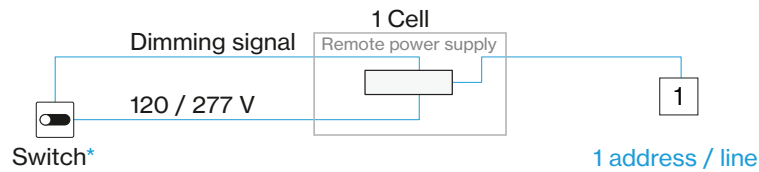

#### 0-10V DIM Dual Circuit

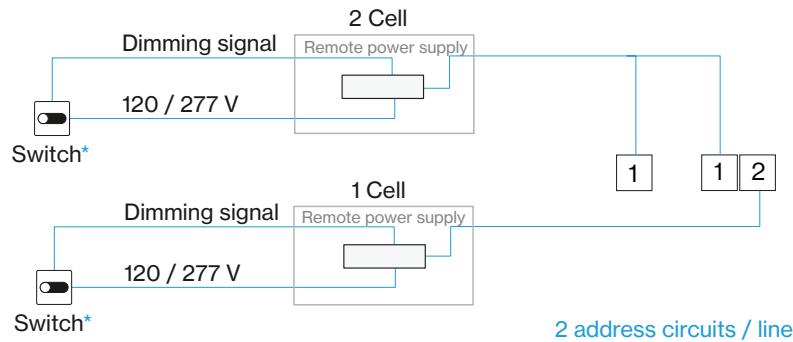

#### 0-10V DIM Tri Circuit

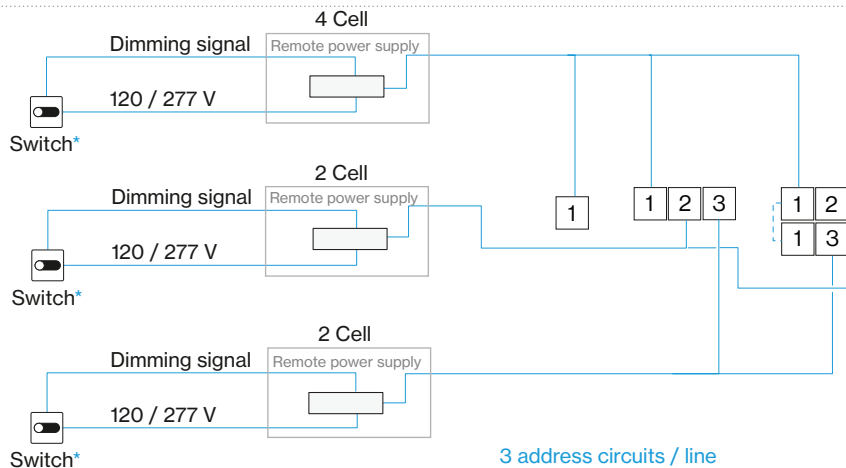

## Wiring diagrams continued

### 0-10V DIM Quad Circuit

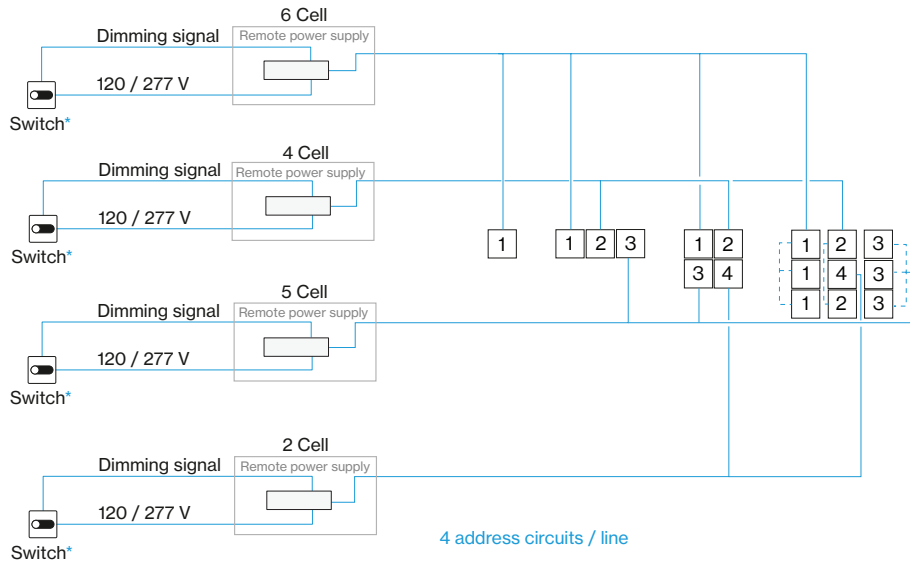

## Length range per power supply

### POWER SUPPLY

Length A max 150'

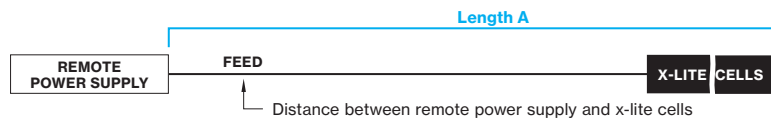

## Declare.

### X-LITE BASO Inc.

Final Assembly: Oxford, Connecticut, USA  
 Life Expectancy: 7 Year(s)  
 End of Life Options: Recyclable (80%), Landfill (20%)

#### Ingredients:

Steel manufacture, chemicals: Aluminum; Small electrical components: Polyvinyl chloride (chlorine chloride (Cl<sub>2</sub>)), Poly(mino(1,6-dioxo-1,6-hexanedyl)impro-1,6-hexanedyl)

↳ LBC Temp Exception RL-002 - Small Electrical Components

#### Living Building Challenge Criteria:

↳ 13 Red List:  
 ☐ LBC Red List Free      % Disclosed: 100% at 100ppm  
 ☐ LBC Red List Approved      VOC Content: Not Applicable  
 ■ Declared  
 ↳ 10 Interior Performance: Not Applicable  
 ↳ 14 Responsible Sourcing: Not Applicable

BAS-0003  
 EXR 01 JUL 2025  
 Original Issue Date: 2024

INTERNATIONAL LIVING FUTURE INSTITUTE™ [livingfuture.org/declare](http://www.livingfuture.org/declare)

## Mounting instructions

Get access to the mounting instructions faster by scanning the QR code.

<https://www.basolighting.com/resources/mounting-instructions/x-lite>

